

Assembly Instructions Cola Bunk Bed

Part in Box 1

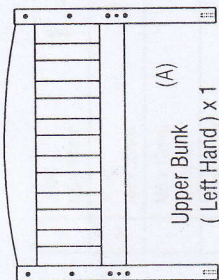

Note : No Holes!

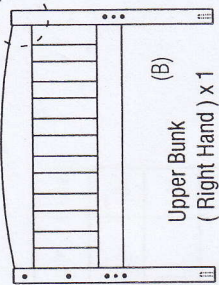

Part in Box 2

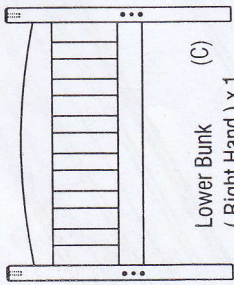
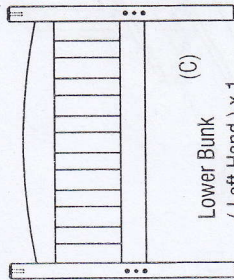

Part in Box 3

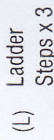
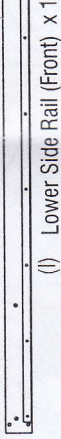
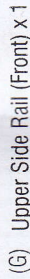
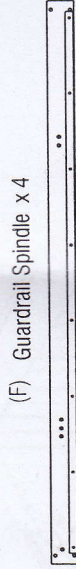
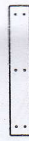
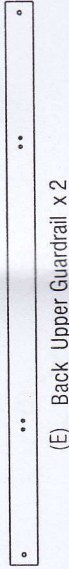
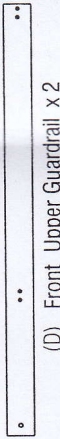

Part in Box 4

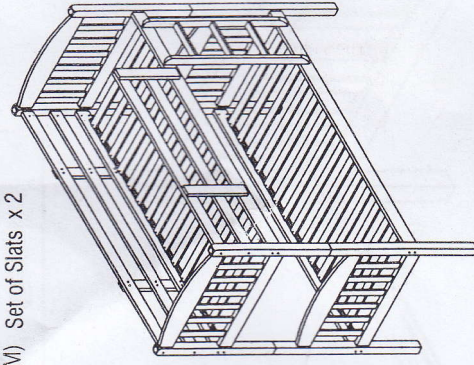
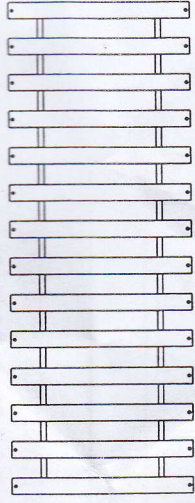

Hardware List

1.	JCBC M6 x 90mm		x 22	Metal Pin M10 x 100mm		x 4
2.	JCBC M6 x 35mm		x 50	CSK M4 x 25mm		x 40
3.	M6 x 13mm Barrel Nut		x 22	M4 Allen Key		x 1
4.	Wood Dowel M10 x 40mm		x 14	Wooden Button 11.5mm		x 4

Tool required for assembly :

- * Allen Key (supplied)
- * Phillips Screwdriver (not supplied)



WARNING !!

- This package contains small parts. Keep away from children until assembly.
 - Adult assembly required.
 - Phillips head screw driver required.
 - Instructions are generic. Figures may vary.
 - Screws left after assembly should be kept out of reach of children.
- NOTE : Children under the age of 9 should not use the upper bunk due to the statistical chance of significant injury.
- Children should be discouraged from playing on the bunk bed.
 - The bunk bed should be checked periodically to ensure that the guardrail, ladder and other components are maintained in the correct position and state of repair and all connectors are tight.
 - The upper bunk must be more than 2m from any ceiling fan.

Assembly Instructions Cola Bunk Bed

2/4

1 Assemble the Upper Bunk (A&B) with the Side Rails (G&H) and Front & Back Guard Rails (D&E).

1.	JCBC M6 x 90mm	x 14
2.	JCBC M6 x 35mm	x 24
3.	M6 x 13mm Barrel Nut	x 14
4.	Wood Dowel M10 x 40mm	x 4

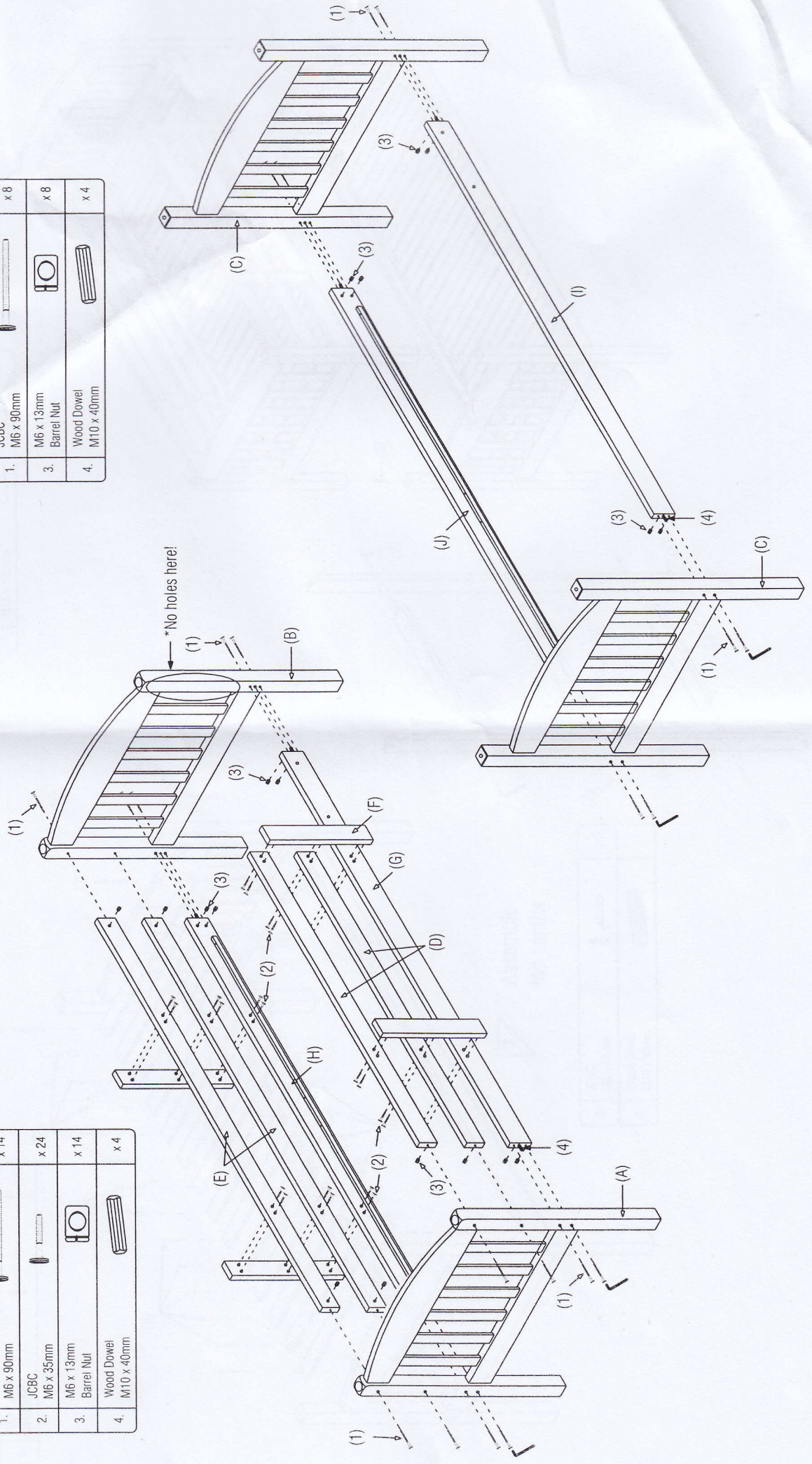

2 Assemble the Lower Bunk (C) with the Lower Side Rails (I&J).

1.	JCBC M6 x 90mm	x 8
3.	M6 x 13mm Barrel Nut	x 8
4.	Wood Dowel M10 x 40mm	x 4



Assembly Instructions Cola Bunk Bed

3 Assemble the Slats (M) to the Upper & Lower Bunk

JCBC		x 16
2.	M6 x 35mm	
CSK Screw		x 40
6.	M4 x 25mm	

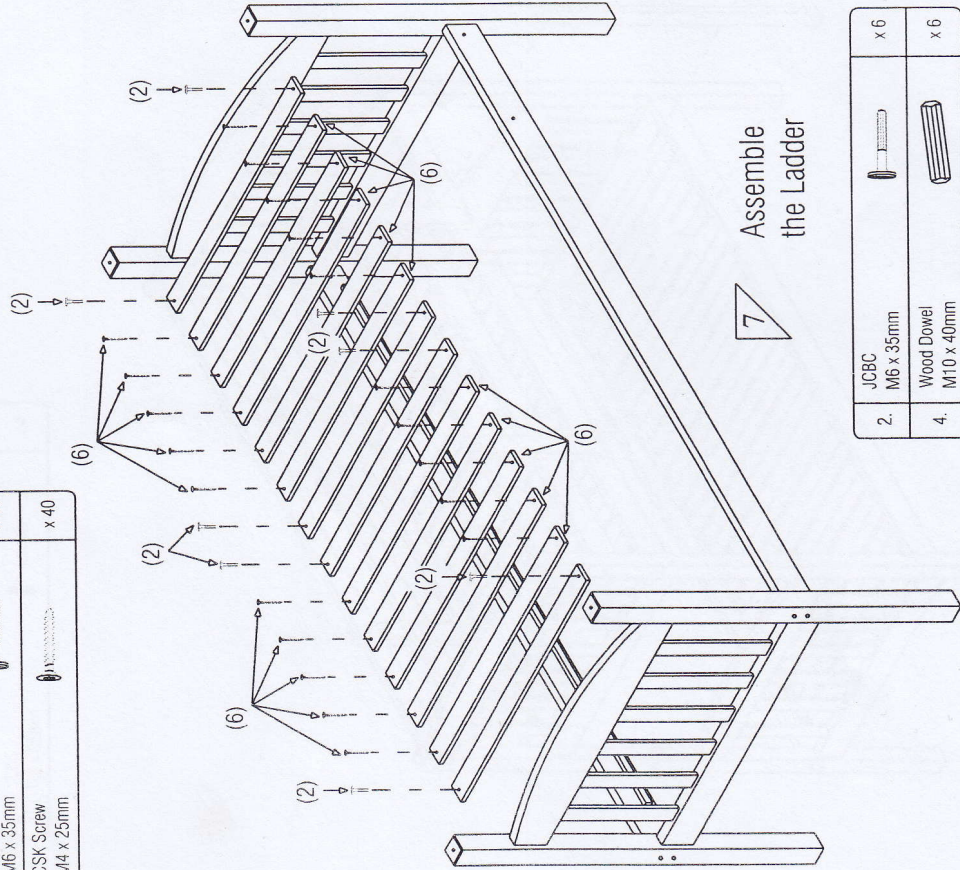

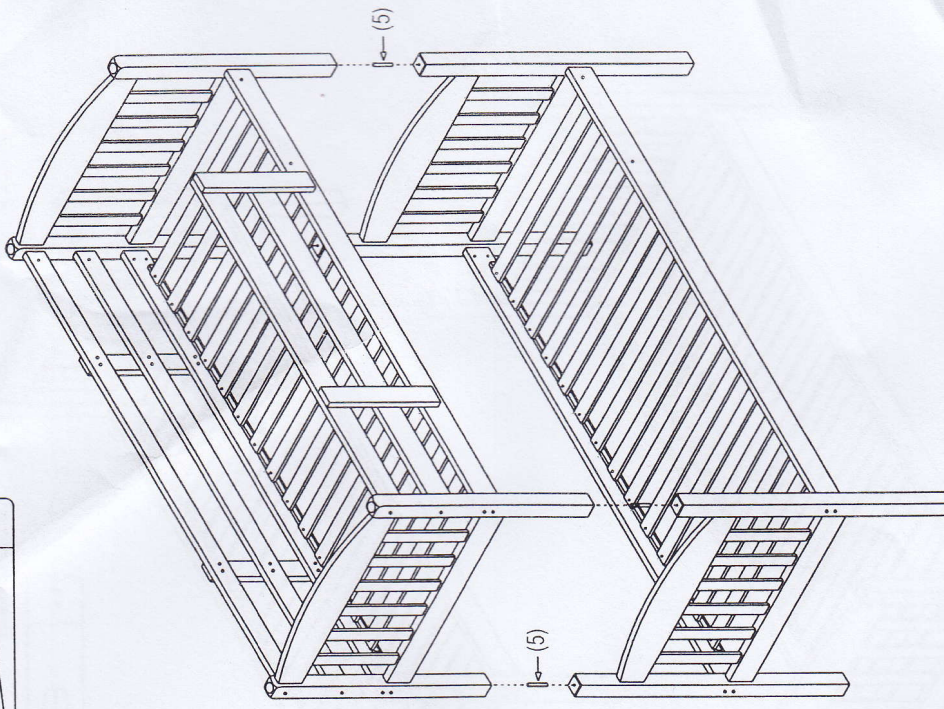

4 Join the Upper & Lower Bunk

5.		x 4
	M10 x 100mm	



7 Assemble the Ladder

JCBC		x 6
2.	M6 x 35mm	
Wood Dowel		x 6
4.	M10 x 40mm	

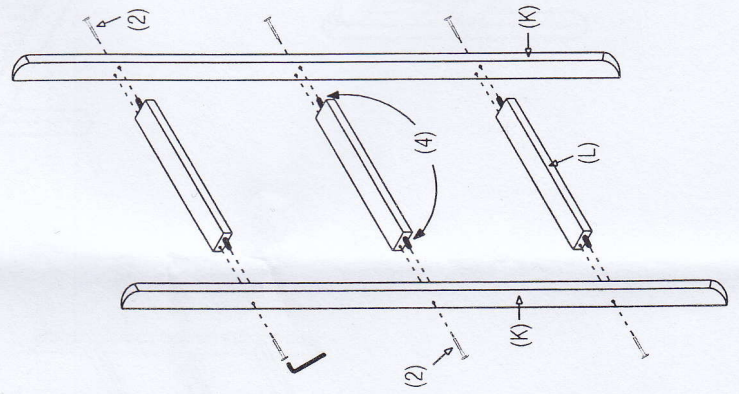

Assembly Instructions Cola Bunk Bed

4/4

6 Attach the Ladder to the Upper & Lower Bunk.

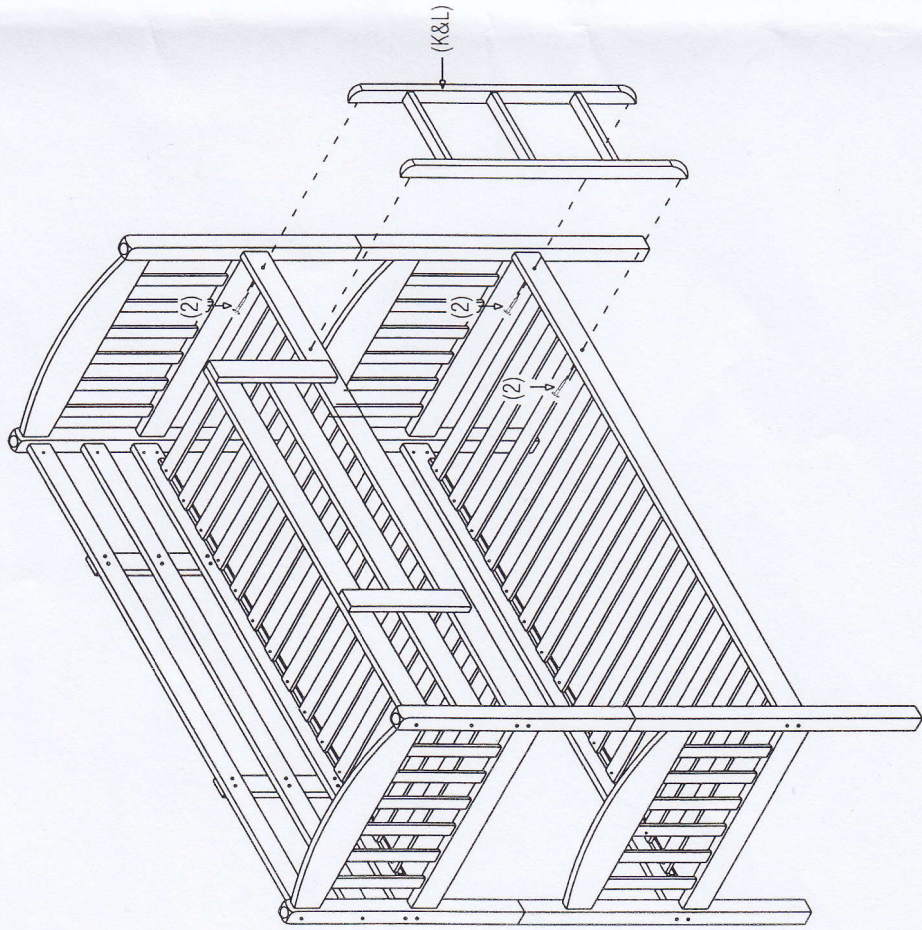

7

Optional use of bunk bed as separate Twin Beds

Use the Lower Bunk as a Headboard.

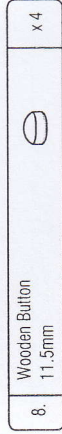

Fit the Small Wood Buttons (8) into the holes at the top.

Use the Upper Bunk as a Footboard.

